

JVC



ENGLISH

VHS • VideoCD COMBO

HR-VCD1

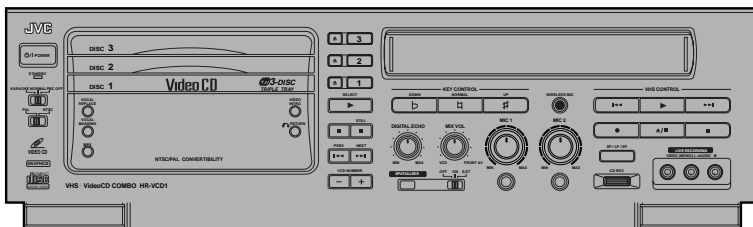
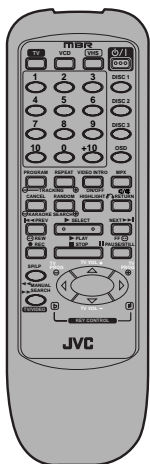

PlayBack
Control

COMPACT
disc
DIGITAL AUDIO

COMPACT
disc
DIGITAL AUDIO
GRAPHICS

COMPACT
disc
DIGITAL VIDEO

Video CD

Hi-Fi VHS
PAL NTSC

INSTRUCTIONS

Table of Contents

Thank you for purchasing this JVC VHS • VideoCD COMBO. To ensure optimum performance of this unit, please read this instruction manual thoroughly.

Precautions	3
General Information	4
Controls, Indicators and Terminals	5
Front panel	5
Wireless remote control	6
TV Multi-Brand Remote Control	7
Display panel	8
Rear panel	8
Connections	9
Basic Playback (Video CD)	10
Various Unique Functions	13
Playback Control Function	16
The video cassette	18
Playback (Video cassette player)	18
Playback Features	19
Recording	20
Karaoke Features	21
Editing	26
CD Recording	27
Live Recording	28
Troubleshooting	30
Specifications	31

Features

- Triple disc tray
- Program playback
- Video intro search
- Highlight search
- Playback control function
- TV multi-brand remote control
- Digital auto tracking
- Spatializer
- CD Recording
- Live recording

Automatic features

Auto power on

This Player is automatically turned on when the tape is inserted.

Auto rewind

The video tape is automatically rewound when the end of the tape is reached during the play, recording or shuttle search forward mode.

Auto playback

If the video cassette's safety tab has been removed, playback will begin automatically when the tape is inserted into the Player.

Power off eject

Even when the Player's power is off, pressing the eject button will turn the power on and eject the tape. Once ejected, the power will be turned off again automatically.



- Only cassettes marked "VHS" can be used with this Player.
- Certain audio features of this product manufactured under a license from Desper Products, Inc. Spatializer® is a trademark owned by Desper Products, Inc.

Precautions

Safety precautions

The rating plate and the safety caution are on the rear of the unit.

WARNING: DANGEROUS VOLTAGE INSIDE

WARNING: TO PREVENT FIRE OR SHOCK HAZARD, DO NOT EXPOSE THIS UNIT TO RAIN OR MOISTURE.

The POWER ϕ/I button does not completely shut off mains power from the unit, but switches operating current on and off. “ ϕ ” shows electrical power standby and “I” shows ON.

This unit produced to comply with Standard IEC Publ. 65.

CAUTION:

- When you are not using the Player for a long period of time, it is recommended that you disconnect the power cord from the AC outlet.
- Dangerous voltage inside. Refer internal servicing to qualified service personnel. To prevent electric shock or fire hazard, remove the power cord from the AC outlet prior to connecting or disconnecting any signal lead or aerial.
- This unit operates on voltage of AC110 – 240 V~(Rating), AC90 – 260 V~(operating), 50/60 Hz with automatic switching.

Precautions

Please follow these precautions. Not doing so may result in damage to the Player, remote control, or video cassette.

- Avoid extreme heat and direct sunlight.
- Avoid extreme cold.
- Avoid extreme humidity.
- Avoid dust.
- Avoid places subject to vibrations.
- Avoid strong magnetic fields.
- Do not block the Player's ventilation openings.
- Do not place anything heavy on the Player or remote control.
- Do not Place anything which might spill on top of the Player or remote control.
- Do not place the Player on cushions, pillows, or thick carpeting.
- Use the Player in a stable, horizontal position only.
- Place cassettes in cassette cases and store vertically.

When transporting

- Be sure to remove cassette and CD from Player before packing.
- Avoid violent shocks to the Player during packing and transport.

Importants

- Video tapes recorded with this Player in the LP (Long Play) or EP (Extended Play) mode cannot be played back on a single-speed video recorder.
- It may be unlawful to record or playback copyrighted material without the consent of the copyright owner.

Beware of moisture condensation

Moisture in the air will condense on the recorder when you move it from a cold place to a warm place, or under extremely humid conditions — just as water droplets form on the surface of a glass filled with cold liquid. Moisture condensation on the head drum will cause damage to the tape. In conditions where condensation may occur, keep the recorder's power turned on for a few hours to let the moisture dry.

Special note on head cleaning

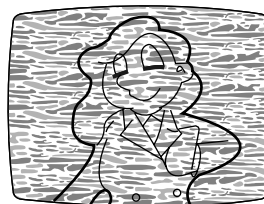

Accumulation of dirt and other particles on the video heads may cause the playback picture to become blurred or interrupted. Although this model is equipped with a built-in head cleaner which automatically cleans the heads, reducing the likelihood of dirty heads, if such troubles are encountered please consult the nearest JVC dealer.

Auto Head Cleaner

A built-in head cleaner automatically cleans the video heads and head drum whenever a tape is loaded or unloaded to reduce head clogging.

ATTENTION:

This Player contains microcomputers. External electronic noise or interference could cause malfunctioning. In such cases, switch the power off and unplug the power cord. Then plug it in again and switch on. Take out the cassette. After checking the cassette, operate the unit as usual.

General Information

Care and handling of compact discs

How to handle CDs

When handling a compact disc, do not touch the surface of the disc (reflective silver side — the side without the label). Since compact discs are made of plastic, they are easily damaged. If a disc gets dirty, dusty, scratched or warped, the sound will not be picked up correctly and, in addition, such a disc may cause the CD player to malfunction.

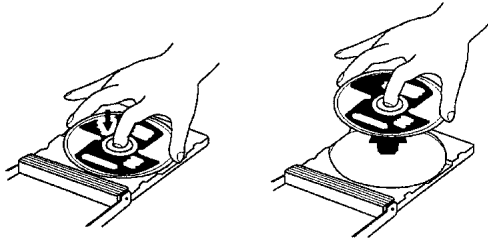

Even on label side

Do not damage the label side, stick paper to or use any adhesive on its surface.

Storage

Make sure that discs are kept in their cases. If discs are piled one on top of another without their protective cases, they can be damaged. Do not put discs in a location where they may be exposed to direct sunlight, or in a place where the humidity or temperature is high. Avoid leaving discs in your car!

Maintenance of discs

If there are fingerprints or other dirt adhering to a disc, wipe it with a soft dry cloth, moving from the center outwards. If a disc is difficult to clean, wipe with a cloth moistened with water. Never use record cleaners, petrol, alcohol or any anti-static agents.

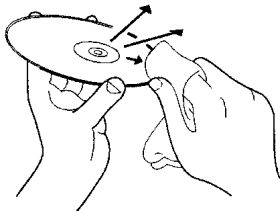

CAUTION

Sometimes during play noise or images may be garbled. This is sometimes due to the disc. (It may not be up to industry standards.) These symptoms are caused by the discs, not by the malfunction of the Player.

Which compact discs can be used?

Many types of compact discs are sold for a variety of uses. The Video CD Player can play the following compact discs:

- **Video CD**
for audio and video (moving picture) reproduction, including multiplex sound.
- **Video CD with Playback Control function**
featuring menu-type operation and super-fine still pictures for audio and video (moving picture) reproduction, including multiplex sound.
- **CD Graphics (CD-G)**
for audio and video (still picture) reproduction, including multiplex sound.
- **Digital Audio CD, including single discs**
for audio reproduction.



PlayBack Control



CDs you can't play back

Do not play back CD-ROMs on this equipment. Doing so may generate a noise which can damage your speakers.

Using the remote control

The remote control is ready to use when its batteries are installed properly.

To use it, point its infrared light-emitting window toward the display window of the player and press a button. The operating range of the remote control is up to about seven meters in front of the player and within about 30 degrees to each side — with nothing between the remote control and the player interrupting the beam path.

If pressing a button on the remote control does not produce any response, check to make sure it is pointed correctly and try again. If it still does not function, check the batteries.

Controls, Indicators and Terminals

Front panel

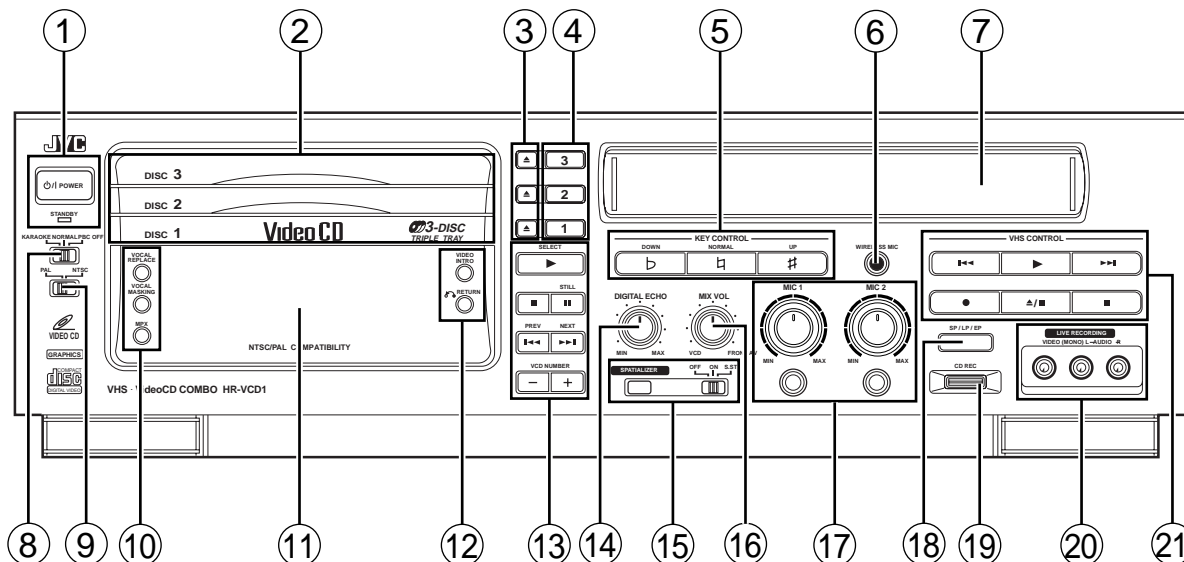

- ① POWER / button / STANDBY indicator
- ② DISC 1 to DISC 3 trays
- ③ Open/Close buttons (Disc number 1 to 3) p.11
- ④ DISC 1 through DISC 3 buttons with indicators p.10
- ⑤ KEY CONTROL buttons p.25
- ⑥ WIRELESS MIC button with indicator p.23
- ⑦ Cassette loading slot
- ⑧ MODE switch p.10
- ⑨ Video out select switch p.9
- ⑩ VOCAL REPLACE button p.25
VOCAL MASKING button p.25
MPX button p.14
- ⑪ Display panel p.8
- ⑫ VIDEO INTRO button p.14
 RETURN button p.16
- ⑬ SELECT button p.11
 Stop button p.12
 STILL button p.12
 PREV / NEXT buttons p.12
VCD NUMBER -/+ buttons p.16
- ⑭ DIGITAL ECHO knob p.25
- ⑮ SPATIALIZER switch and indicator p.20
- ⑯ MIX VOL knob p.29
- ⑰ MIC 1 and MIC2 knobs and MIC input terminals p.25
- ⑱ SP/LP/EP button p.20
- ⑲ CD REC button with indicator p.27,29
- ⑳ VIDEO/AUDIO input terminals p.26,28
- ㉑ VHS CONTROL buttons
 / Karaoke search buttons p.20
 Play button p.18
 Record button p.20
 / Stop/Eject button p.18
 Pause/Still button p.20

WARNING of cassette loading slot

- Do not insert fingers or foreign objects into the cassette loading slot since this could lead to injury or damage to the mechanism. Be especially careful with children.
- Do not try to pull out a cassette once automatic loading has started.

Controls, Indicators and Terminals (cont'd)

Wireless remote control

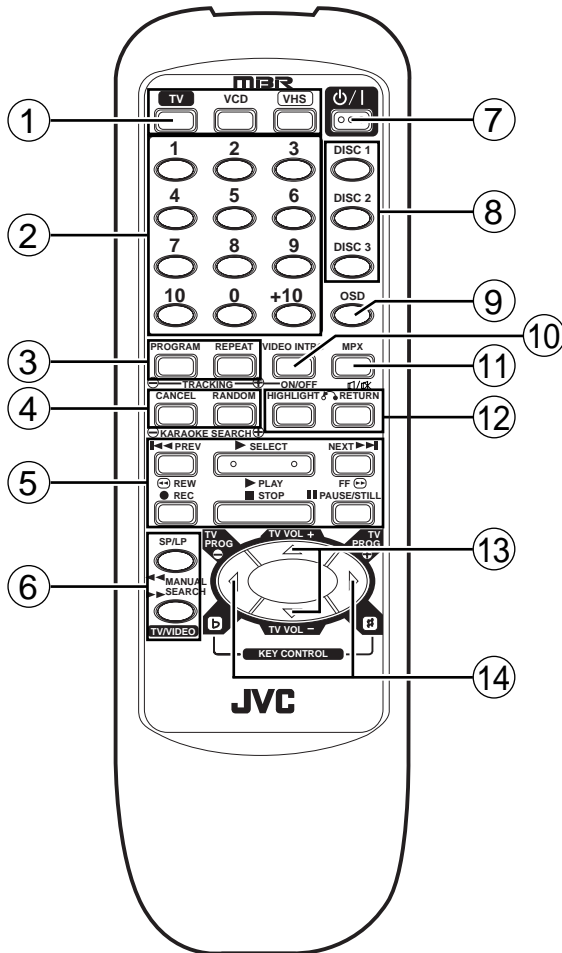

- ① TV, VCD, VCP control buttons
First press these buttons before beginning to operate the equipment.
- ② Number keys [p.11](#)
- ③ PROGRAM button [VCD] [p.13](#)
REPEAT button [VCD] [p.14](#)
TRACKING +/- buttons [VCP] [p.19](#)
- ④ CANCEL button [VCD] [p.13](#)
RANDOM button [VCD] [p.14](#)
KARAOKE SEARCH +/- buttons [VCP] [p.20](#)
- ⑤ [VCD operation buttons]
◀◀ PREV / ▶▶ NEXT buttons [p.12](#)
▶ SELECT button [p.11](#)
■ STOP button [p.12](#)
|| PAUSE/STILL button [p.12](#)

[VCP operation buttons]
▶ PLAY / ◀◀ REW / ▶▶ FF / ■ STOP buttons [p.18](#)
● REC / || PAUSE/STILL buttons [p.20](#)
- ⑥ SP/LP button [VCP] [p.20](#)
TV/VIDEO button [TV] [p.7](#)
MANUAL SEARCH ◀◀ / ▶▶ buttons [VCD] [p.12](#)
- ⑦ POWER button
- ⑧ DISC 1 through DISC 3 buttons [VCD] [p.10](#)
- ⑨ OSD button [VCD] [p.13](#)
- ⑩ VIDEO INTRO button [VCD] [p.14](#)
AUTO TRACKING ON/OFF button [VCP] [p.19](#)
- ⑪ MPX button [VCD] [p.14](#)
TV sound mute button [TV] [p.7](#)
Audio monitor button [VCP] [p.19](#)
- ⑫ HIGHLIGHT button [VCD] [p.15](#)
RETURN button [VCD] [p.16](#)
- ⑬ TV VOL +/- buttons [TV] [p.7](#)
- ⑭ TV PROG +/- buttons [TV] [p.7](#)
KEY CONTROL b/# buttons [VCD] [p.25](#)

Installing Batteries

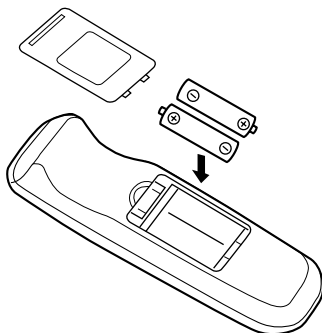

- 1 Open the battery compartment cover.
- 2 Insert 2 "AA/UM-3" size batteries (provided) in the correct directions.
- 3 Replace the cover.

Controls, Indicators and Terminals (cont'd)

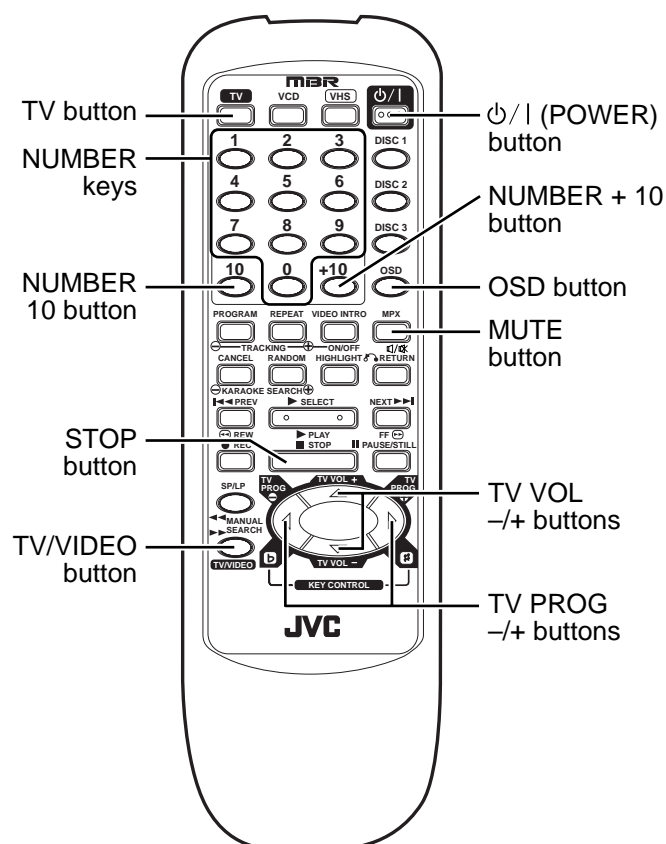

TV Multi-Brand Remote Control

Your remote control can operate the basic functions of your TV set. In addition to JVC TVs, other manufacturer's TVs can also be controlled.

Before you start...

- Turn on the TV using its remote control.
- Press the TV button on the remote control.

NOTE:

- If your TV is a JVC, you don't have to set the code in step 1. Go to step 2.

1 SET TV BRAND CODE

Refer to the chart below. While holding down TV, enter your TV's brand code using the NUMBER keys, then press STOP.

- You don't have to repeat this step until you replace your remote control's batteries.

2 TRY OPERATING TV

Press ⏻ on the remote control to turn the TV off. If it goes off, try other operations.

- The ⏻ button, TV/VIDEO button, TV PROG +/- button, TV VOL +/- button and MUTE button on the remote control can all be used to operate the TV.

IMPORTANT

Although the provided remote control unit is compatible with JVC televisions, as well as many other models, it may not work with your TV, or in some instances, may have limited function capability.

Control Your TV Using Additional Buttons

The NUMBER keys on the remote control can also be used to select the TV's channel by setting the remote control to the TV mode.

- 1 Press the TV button.
- 2 Use the NUMBER keys, and the DIGIT ENTRY (NUMBER 10) button, the NUMBER +10 button or the OSD button to select the TV's channel.

- DIGIT ENTRY (NUMBER 10) button corresponds to the 1-digit/2-digit entry switching button (often labelled -- --) of your TV's remote control.
- NUMBER +10 button corresponds to the 10 + button, and the OSD button corresponds to the 20 + button of your TV's remote control.

NOTE:

- The way these buttons are used is determined by your TV. Use these buttons as instructed for your TV's remote control.

TV BRAND NAME	CODE
JVC	01
AIWA	10
BEIJING	05, 27
CHANGHONG	05, 06, 16, 25
DAEWOO	11
FERGUSON	15
FINLUX	20
FUNAI	09
GOLDSTAR	13
GRUNDIG	17
HITACHI	07
ITT	18
JINXING	23
KONKA	26
MITSUBISHI	06
MIVER	19
NEC	22
NOBLEX	27
NOKIA	21
PANASONIC	02
PEONY	23, 24, 25
PHILIPS	16
SAMSUNG	12
SANYO	08
SHARP	04
SONY	03
TCL	16, 28
THOMSON	14
TOSHIBA	05

Controls, Indicators and Terminals (cont'd)

Display panel

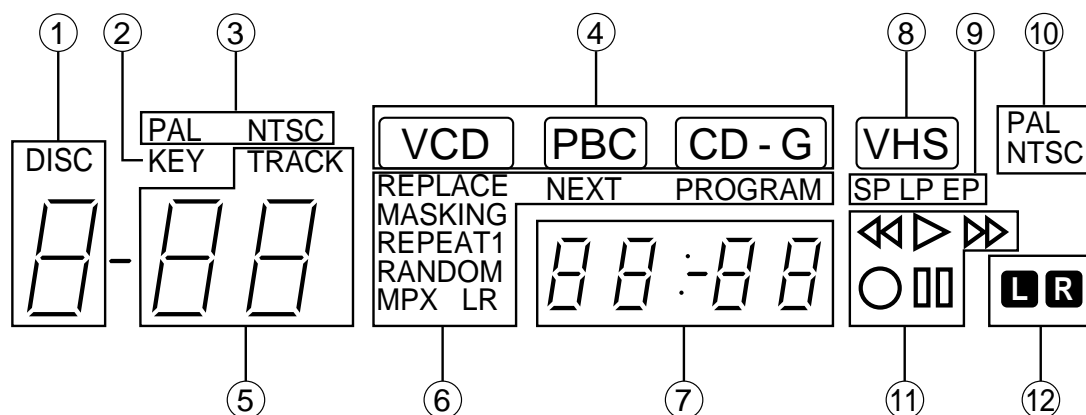

[VCD display]

- ① Disc number indicator
- ② Key control indicator
- ③ Colour system indicator
- ④ Type of disc indicator
- ⑤ Track number indicator
Total number of tracks indicator
- ⑥ Each indicator in this area lights when the corresponding function is activated.
- ⑦ Cumulative time of the track indicator
Total time of the disc indicator

[VCP display]

- ⑧ VHS mode indicator
- ⑨ Tape speed indicator
- ⑩ Colour system indicator
- ⑪ Symbolic mode indicator

▶	Play	●	Record	●	Record pause
◀◀	Rewind	◀◀	Shuttle search (reverse)		Still/Slow
▶▶	Fast forward	▶▶	Shuttle search (forward)		

- ⑫ Audio mode indicator

Rear panel

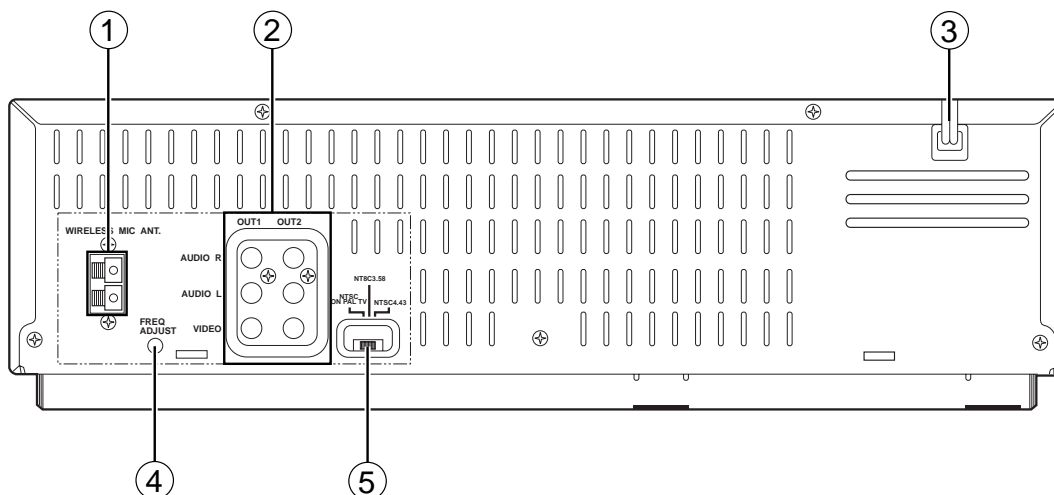

- ① Wireless MIC antenna terminals [p.23](#)
- ② VIDEO/AUDIO output terminals [p.9,26](#)
- ③ Power cord
- ④ MIC Frequency Adjustment screws [p.23](#)
- ⑤ Colour System Output switch [p.9](#)

Connections

Make sure that the power to the Player and TV is off before making the following connections.

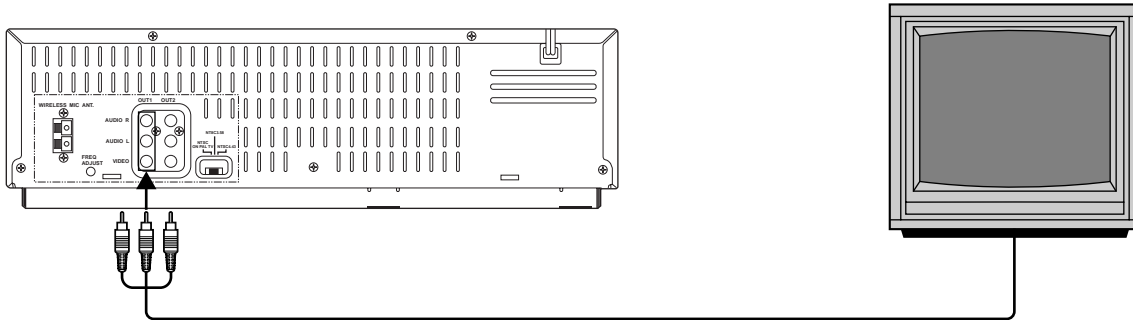

How to connection

- 1 Connect the TV's VIDEO input and AUDIO input terminals to the Player's VIDEO output and AUDIO output terminals.
- 2 Connect the power cord to your household AC outlet.

Notes:

- Connection not available with television sets without audio/video input terminals.
- If you put a TV set directly on this Player or install it too close to a TV set, noise may occur. If this noise occurs, separate the Player and the TV set.

Video out select (VCD)

Set the VIDEO OUT SELECT switch on the front panel to NTSC or PAL mode according to your television system.

NTSC for NTSC exclusive TV

PAL for PAL exclusive TV

Note:

- If the wrong video system mode for the Video CD is selected, it will not playback with the correct screen size.

Colour system output mode selection (VCP)

To watch an NTSC tape, it will be necessary to select one of the following output modes.

Selecting the NTSC PLAYBACK ON PAL TV mode

Select this mode to watch NTSC tapes on a PAL system TV.

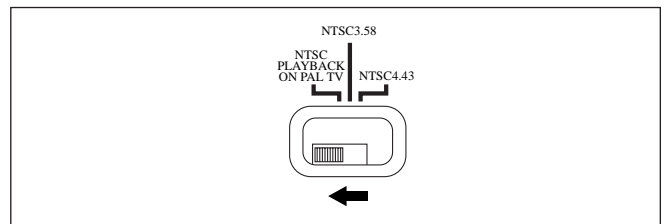

Selecting the NTSC 3.58 mode

Select this mode to watch NTSC tapes on a NTSC system TV.

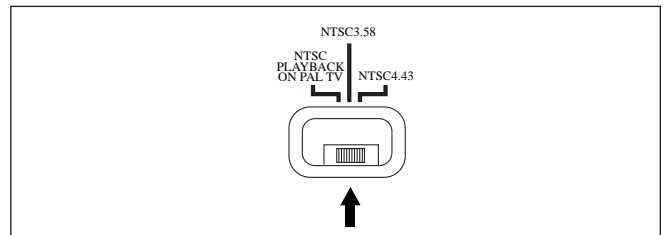

Selecting the NTSC 4.43 mode

Select this mode to watch NTSC tapes on a multi-system TV (that has an NTSC 4.43 setting).

Select NTSC 4.43 to record NTSC 4.43 signal.

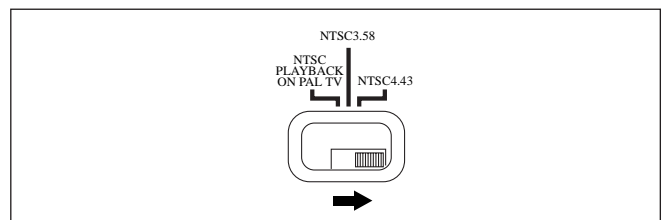

Note:

- Adjust the System Output switch to the appropriate position in order to record NTSC signals.
 Select the NTSC PLAYBACK ON PAL TV or NTSC 3.58 to record NTSC 3.58 signals.
 Select NTSC 4.43 to record NTSC 4.43 signals.

Basic Playback (Video CD)

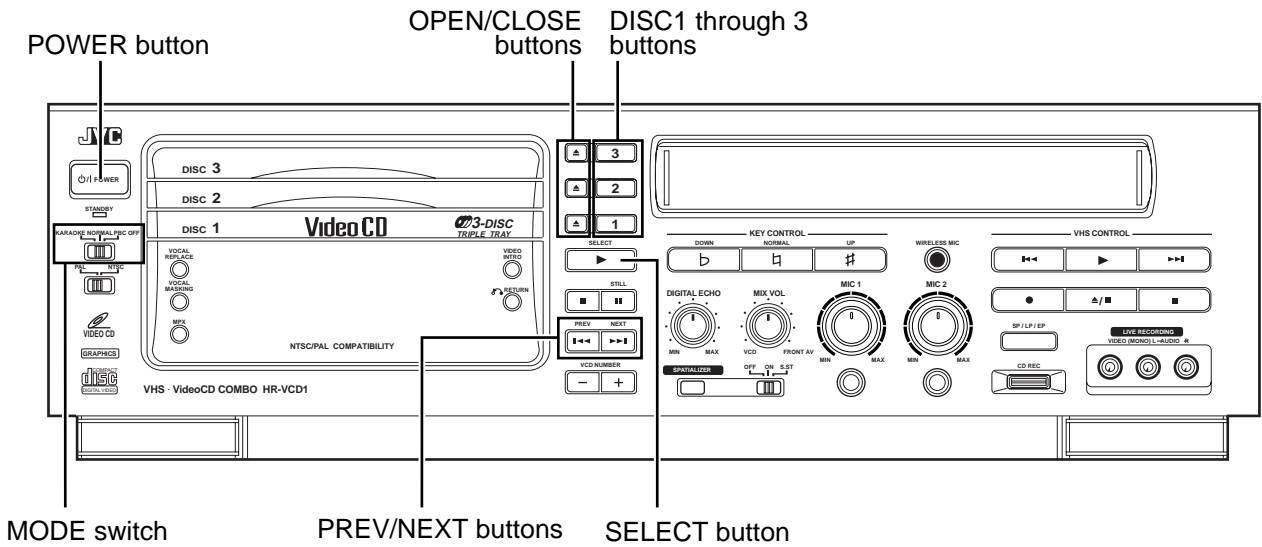

Overview of the three modes

This Player has three (3) modes called KARAOKE, NORMAL, and PBC OFF mode. These are selected by the MODE switch. This enables various ways of playing a video CD.

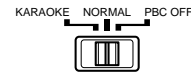

- KARAOKE mode** : One track playing mode. Whenever one track has completed play, the Player stops.
- NORMAL mode** : Continuous plural tracks playing mode. The Player plays tracks continuously in the order they appear on the disc.
- PBC OFF mode** : This mode is identical to the NORMAL mode, except that the PBC function is inhibited.

To set the mode, switch the MODE switch on the left side of the front panel.

Triple disc tray usage

Up to three (3) discs can be loaded in the Player. You may insert a disc into any of the disc trays 1 through 3 whichever you prefer. If you want to play only a specified disc, press the corresponding disc 1, 2 or 3 button located to the right of the ▲ (OPEN/CLOSE) button.

When three discs are inserted, basic order of playing is as following.

- Pressing DISC 1: DISC 1 → DISC 2 → DISC 3 → STOP
- Pressing DISC 2: DISC 2 → DISC 3 → DISC 1 → STOP
- Pressing DISC 3: DISC 3 → DISC 1 → DISC 2 → STOP

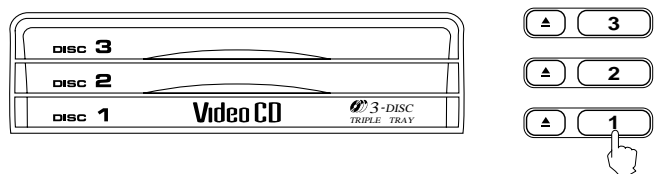
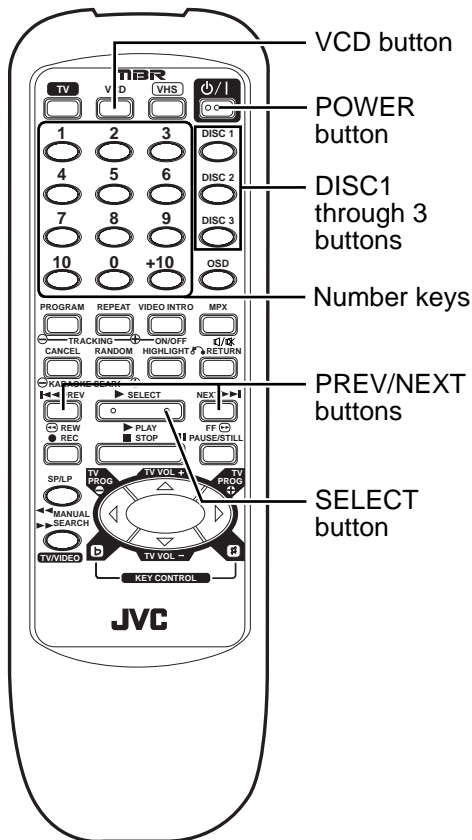

Basic Playback (Video CD) (cont'd)

In order to operate by remote control, first press the VCD button.

Preparation for playing

Turn on the television set, amplifier or receiver to which the Player is connected, and then select the proper channel and mode to operate the Player, and set the sound volume to a reasonable level.

Press the POWER $\odot/|$ button on the front panel or remote control.

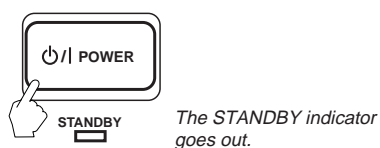

The display window shows the initial information as shown below.

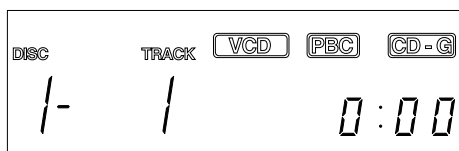

Easy start up

Without pressing the POWER $\odot/|$ button you can start up the Player by pressing \blacktriangleright SELECT button or disc buttons.

Inserting/removing the disc(s)

Press the \blacktriangle (OPEN/CLOSE) button (1 through 3) to open the disc tray. Then place the disc in the round recess of the tray with label side up. To close the tray, press the \blacktriangle (OPEN/CLOSE) button again.

If you press the \blacktriangle (OPEN/CLOSE) button of the playing disc, the Player stops and then opens the tray.

If you press the \blacktriangle (OPEN/CLOSE) button of a disc that is not being played, you can change discs without stopping play.

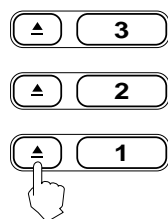

Note :

- When loading a disc in the disc tray, be sure to position the disc inside the recess. Otherwise, the disc will be damaged when the disc tray is closed, and the disc cannot be removed from the unit.

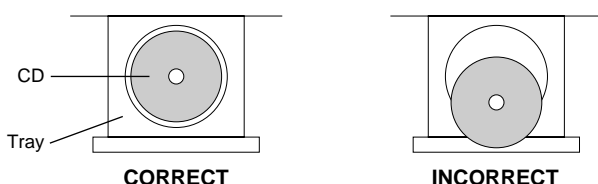

Starting to play disc(s)

Press the \blacktriangleright SELECT (PLAY) button. The Player starts to play from the disc indicated in the Display window. Press one of the DISC 1 through 3 buttons and the Player plays the disc you pressed, from the 1st track. For individual track selection, use the number keys on the remote control.

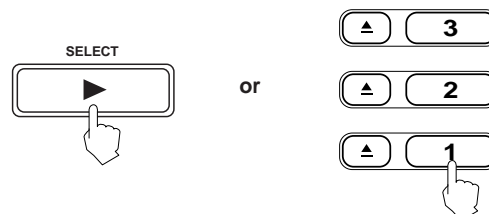

When you start play, the Display window shows disc number and the track number being played.

During play, the indicator on the DISC button blinks.

If the PBC function is activated, the display window shows "Pb" and the television screen shows the initial menu, DISC number, and "PBC". See page 16 "Playback Control function".

Using number keys

Press the number keys on the remote control to select numbers.

Example: For number 5, press 5. For number 15, press +10, then 5. For number 20, press +10, then 10. For number 32, press +10 three times, then 2.

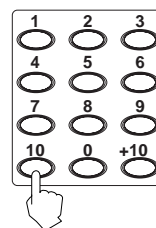

Note :

- When you press number keys, track will start playing without pressing \blacktriangleright SELECT button.

Basic Playback (Video CD) (cont'd)

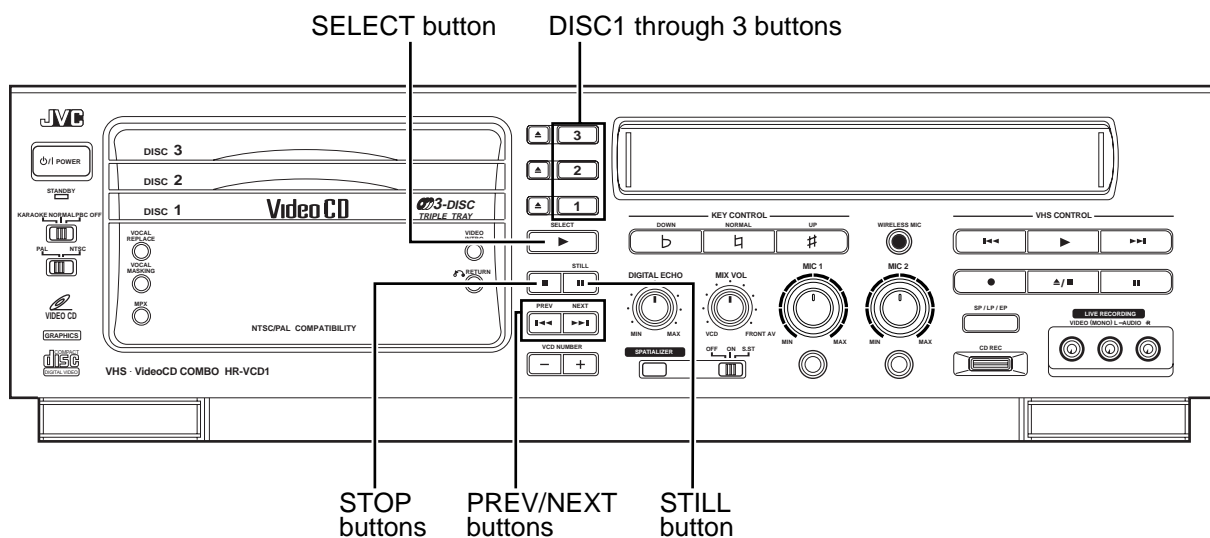

In order to operate by remote control, first press the VCD button.

Stopping play

Press the ■ (STOP) button to stop play at any time.

Pausing play

Press the || STILL (PAUSE) button to temporarily suspend play.

Notes :

- When the || STILL (PAUSE) button is pressed once, "PAUSE" appears on the television screen, the video motion freezes and the sound is turned off. The still picture advances frame-by-frame each time the || STILL (PAUSE) button is pressed. This frame-by-frame function is effective only for video CDs.
- To release the pause, press the SELECT or blinking DISC 1 through 3 button.
- During "PAUSE" the time counter on the display will blink.

Auto search

During play, pressing the ◀◀ PREV button once causes the Player to replay the current track from the beginning. Pressing the ◀◀ PREV button twice causes the Player to play the previous track. Pressing the ▶▶ NEXT button once causes the Player to skip to the next track.

Manual search

Holding down the ◀◀ / ▶▶ MANUAL SEARCH buttons on the remote control or the ◀◀ PREV / ▶▶ NEXT buttons on the front panel cause the disc to fast forward or reverse. Continuing to hold down the buttons causes it to search much faster.

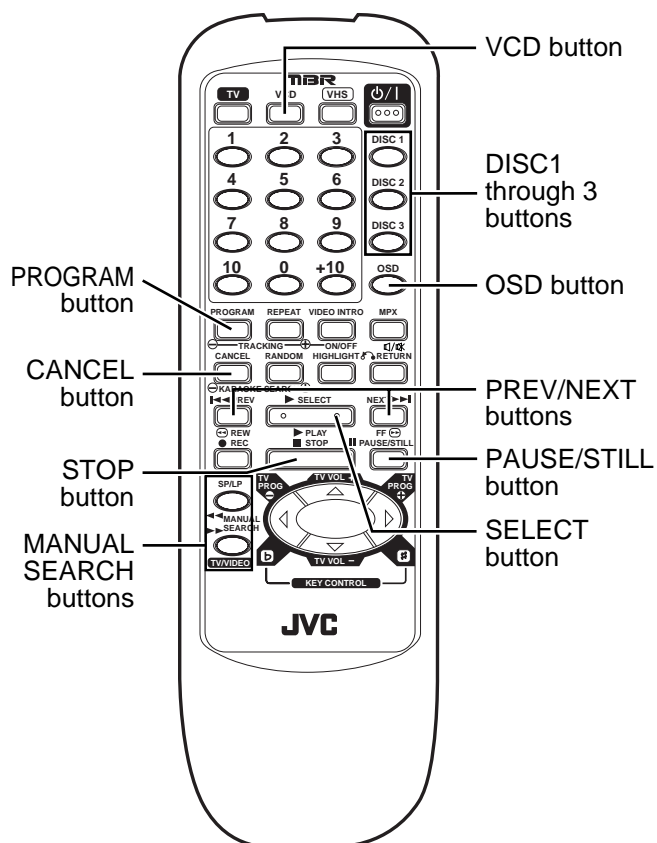

Various Unique Functions

In order to operate by remote control, first press the VCD button.

Display of operations status

Press the OSD button on the remote control. By pressing the OSD button, the following information may be easily and quickly displayed or vanished on the television screen.

Time, Disc mode, Echo effect, Key control, Program, Repeat, Random, Multiplexing, Vocal replace, Vocal masking

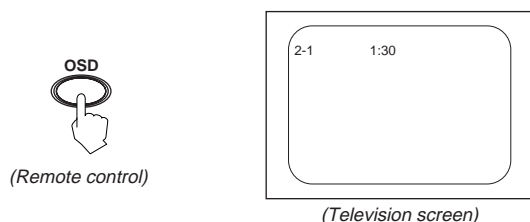

Programming the track sequence you want

Preparation

It is not possible to enter programming mode during play. Verify whether the Player is playing. If playing, stop the player with the ■ STOP button.

Operation

1. Press the PROGRAM button on the remote control to enter the programming mode.



2. Specify the disc by the DISC (1 through 3) button and then the track by the number keys successively. You can program up to nine (9) tracks by repeating this procedure.
3. To play the programmed track press the ► SELECT button.

Notes :

- The track number playing, next track programmed, and number of programmed tracks are displayed from the left-top of the television screen. You may use the OSD button to delete this information.
- Once the programmed track is played, it is deleted from the program.
- You may continue to program even while the disc is playing.

Canceling a programmed track

There are three (3) canceling functions (canceling the last programmed track, canceling the current track, canceling the next track to be played).

- To cancel the last programmed track press the CANCEL button on the remote control and the last programmed track will be canceled. This can be done while a disc is playing.

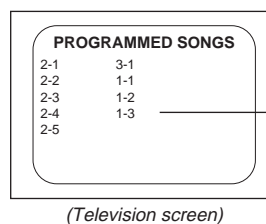

- To cancel the current track press ■ STOP button.
- To cancel the next track, wait until the current track has finished and press the ►► NEXT button and the next track will be canceled and the machine will go to the next programmed track.

Note :

- To verify the track you programmed, stop the Player and see ON SCREEN information.

Clearing a program

To delete all programmed tracks you have entered, press the ■ STOP button and then the PROGRAM button. "PROG OFF" will be displayed on the television screen.

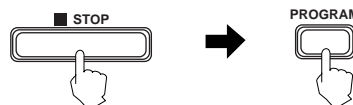

Note :

- The Player does not cancel the track program even if the ■ (STOP) button is pressed. Pressing the ► SELECT (PLAY) button again causes the Player to resume playing from the next track.

Various Unique Functions (cont'd)

In order to operate by remote control, first press the VCD button.

Repeating tracks

It is possible to repeat all discs or only a single track.

Preparation

This function is controlled by the remote control.

Operation

By pressing the REPEAT button, channel REPEAT modes are cycled as shown below.

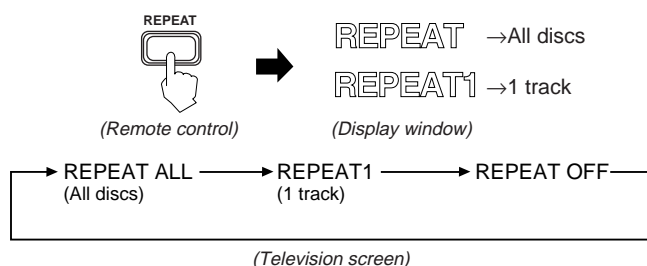

Notes :

- When playing a programmed sequence of tracks, only one track repeat is available.
- Only REPEAT1 is available in KARAOKE mode.

Randomly playing tracks

Preparations

- This function is controlled by the remote control.
- The RANDOM button is effective only in NORMAL/PBC OFF mode.
- This function plays tracks randomly from a single disc.

Operation

1. Stop the Player.
2. Press the RANDOM button and random playing will start.

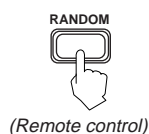

3. To cancel random playing, after stopping the Player [■ (STOP) button], press the RANDOM button again.

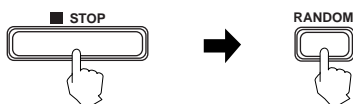

Note :

- Random is not effective in program or KARAOKE mode.

Playing a multiplex sound CD

This function is used for multiplex sound discs.

Operation

By pressing the MPX button, channel multiplexing modes are cycled as shown below.

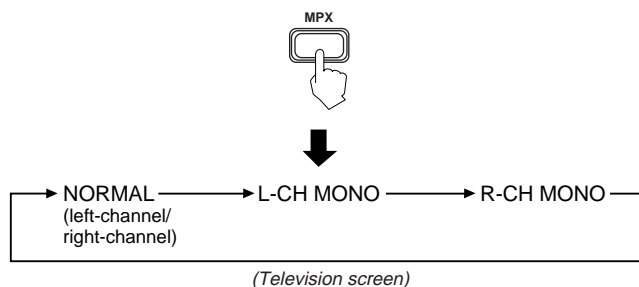

Viewing the VIDEO INTRO of a video CD

Preparation

When you play a video CD with the Playback Control function, the mode switch is recommended to be in the PBC OFF mode or KARAOKE mode.

Operation

1. Play the disc you want to see a digest of.
2. Press the VIDEO INTRO button on the Player or the remote control just after starting disc play. Then the Player starts to display in sequence the first five (5) seconds and track numbers of all tracks on the disc.



3. To select a track during digest display, press the number key corresponding to the item number on the screen.

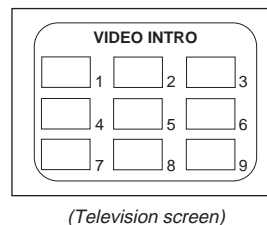

Various Unique Functions (cont'd)

In order to operate by remote control, first press the VCD button.

Programming during VIDEO INTRO

Operation

1. Press the PROGRAM button on the remote control so that PROGRAM is lit in the display.
2. Press the disc button you want to play, and enter 1 on the keypad.
3. Press the ► SELECT button and then, after the disc has started to play, press the VIDEO INTRO button.
4. The Player starts to display in sequence the first five (5) seconds and track numbers of all tracks on the disc. Select the number you want to program. You can program nine (9) tracks.
5. Press the ► SELECT button to play.

Viewing the highlights of a video CD

This function is used for a movie video CD.

Preparations

- When you play a video CD with the Playback Control function, the mode switch is recommended to be in the PBC OFF mode or KARAOKE mode.
- This function is controlled by the remote control unit.

Operation

1. Start playing the track you want to see the highlights of.
2. After the track begins to play, press the HIGHLIGHT button on the remote control.

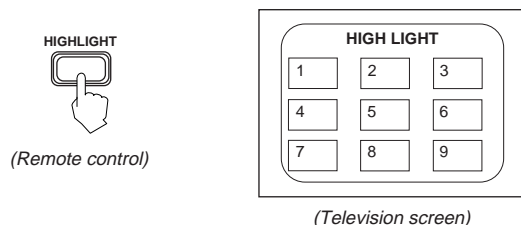

3. To select one of the nine (9) segments, press the number key (1 to 9) of the segment which you want to play.

Notes :

- When you choose a highlight it will start from five (5) seconds before the shown time below each segment.
- The highlights show the proceeding five (5) seconds up to the displayed time on each highlight.
- The segments are each of nine (9) equal-time period divisions of the track.
- Nine (9) different highlights are displayed for one (1) minute.
- If no highlight is chosen in the one (1) minute period in normal mode or PBC OFF mode the next nine (9) segment highlights will begin, in KARAOKE mode highlights will stop.
- While in VIDEO INTRO or HIGHLIGHT, sometimes image is garbled partially. This symptom is caused by noise in the disc itself or incorrect manufacturing, it is not caused by a malfunction of the Player.

Playing CD Graphics

Basic video CD-playing procedures apply although the pictures are still. A CD Graphics is identified by "CD-G" shown on the display.

Notes :

- The following operations may distort the image on the screen.
 - Searching for starting point of music
 - Fast forwarding/reversing
 - Stop/pause
- If paused, the screen changes to blue in a few minutes. This is to prevent burn-in of the TV screen.

Playing digital audio CDs

Basic video CD-playing procedures apply to the reproduction of sound.

Note :

- No indicator will turn on to show the type of the disc on the display.

Playback Control Function

Playing Video CDs with Playback Control function

This Player provides a Playback Control function which utilizes a procedure (menu selection) programmed in a video CD. The playback operation procedure may differ depending on the disc you use.

The Playback Control function is described below and in the figure.

- High-resolution still image display - Super-fine reproduction of still images with more than 4 times the resolution of video tape.
- Menu-driven playback - interactive menus for easy selection of tracks

Preparations

- A video CD with the Playback Control function is required for this operation.
- Only the NORMAL mode can be used.
- The buttons available for use are the number keys, VCD NUMBER +/- buttons, the <<||>> PREV/NEXT buttons, ► SELECT button, DISC (1 through 3) buttons, and ↻ RETURN button.

Button functions

- Player's VCD NUMBER +/- buttons
remote control's Number keys
(Including +10 button) Select a specific menu item from the television screen or monitor.
- <<||>> PREV/NEXT buttons.. Move through menu.
- SELECT button Starts up a video CD with the PBC function in DISC tray 1 to 3.
- DISC (1 through 3) buttons Start up a video CD with the PBC function in the specified DISC tray.
- ↻ RETURN button Returns to the menu.

Operation

1. Verify that the Player is in NORMAL mode.



2. Press the DISC (1 through 3) or ► SELECT button, and then the Player starts up the PBC function. "Pb" is shown in the Display window. The main menu, "PBC", and disc/track number are displayed on the television screen.

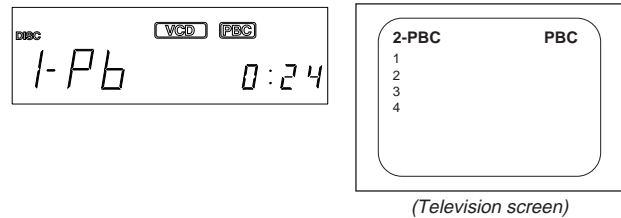
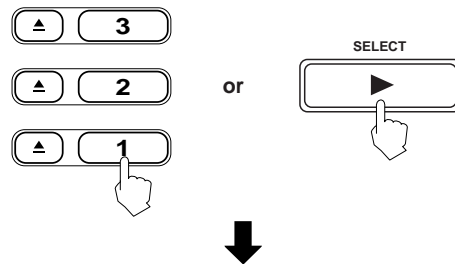

3. To move through the menus, press the <<||>> PREV/NEXT buttons.

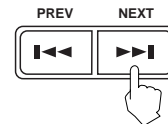

4. When the menu you want appears, select an item in the menu by using the number keys. The numbers on the number keys correspond to the menu item numbers.
5. To return to a menu and stop the track being played, press the ↻ RETURN button.



Notes :

- Page numbers in the menu show that preceding pages exist. To move from the current menu, press the <<||>> PREV/NEXT buttons.
- If you have no desire to use the PBC function when playing a disc with the PBC function, switch the MODE switch to "PBC OFF" before playing.
- When you change the mode switch except NORMAL mode during play Playback Control disc, the play stops, so reset again from the beginning.
- If you press number keys directly to select the track, you can't enter the Player into PBC mode.

Playback Control Function (cont'd)

Video CD with Playback Control function

What is Playback Control function?

The Playback Control function, ushering a new video CD age, allows you to enjoy menu-driven operation and high-resolution still images having a resolution four times greater than moving pictures.

- **Menu-driven playback**
You can interact with the screen using a menu display to select and play an entry.
- **High-resolution still image display**
You can display high-quality images four times clearer than moving pictures.

Example of playback by the Playback Control function

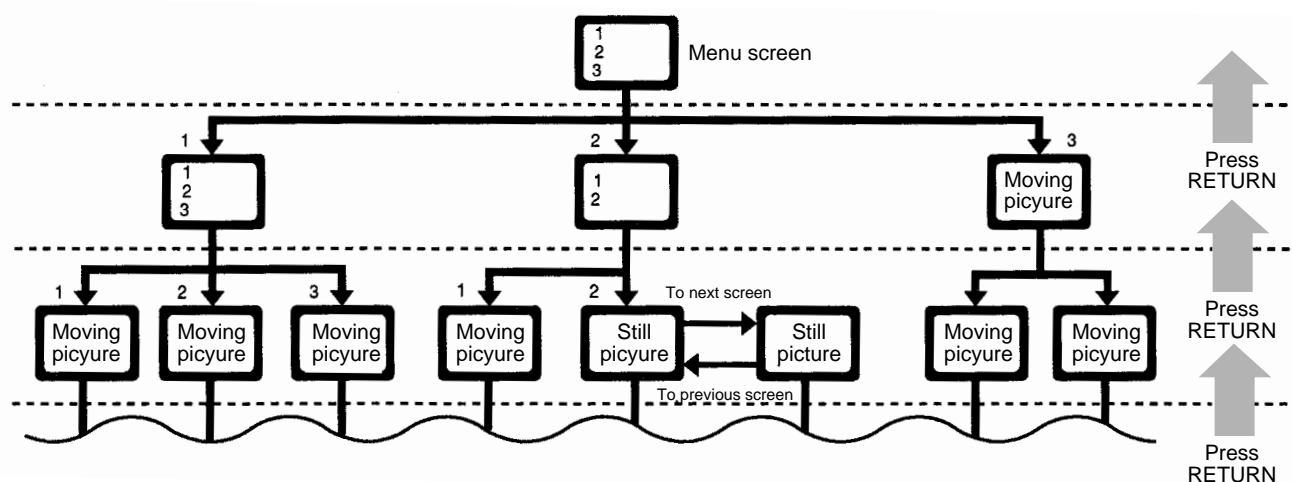

A selection menu is displayed when you start playing a video CD disc with the Playback Control feature. The selection menu shows a list of numbers for selection. Some discs may show moving pictures or a divided screen.

1. When a list of numbers is displayed, selecting a number shows its contents.
2. When a moving picture is displayed, pressing SELECT at the time when a part of the movie you desire is shown plays the movie.
3. When the selection menu is redisplayed after you have played your selection, selecting a number again can replay its contents. (Some discs may show the menu screen several times.)

When "Next" and "Prev" are shown, pressing "NEXT" or "PREV" can change the selection menu.

4. After playback, press RETURN to go back to the previous screen.
After playback, pressing RETURN for 2 seconds or more causes it to go back to the previous menu selection. Some discs may return you to the menu screen shown before playback.

Note :

When a menu is displayed for a long time, about 10 minutes, the screen background automatically fades out to prevent screen burn-in while the setting is suspended.

The video cassette

Inserting a cassette

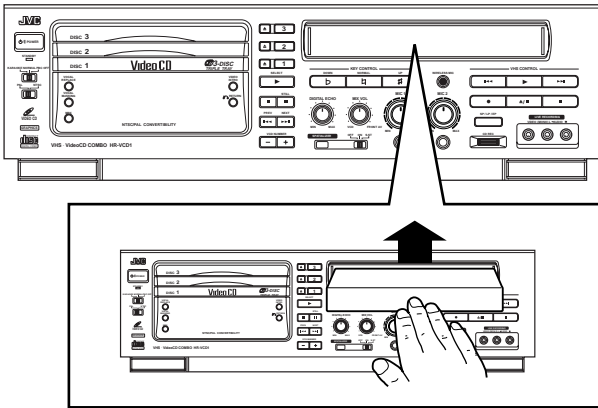

- **Insert the cassette as shown and push it gently into the Player**
The Player will be turned on automatically and the cassette will be loaded.
- **Press the Stop/Eject ■/▲ button to eject a cassette.**
During playback or recording, press the ■/▲ button twice (once to stop the tape and once more to eject it).

Notes:

- If the cassette's safety tab has been removed, playback will start automatically when the cassette is inserted.
- A cassette can also be ejected when the power is off.

Special note on Video Cassettes

To prevent accidental recording on a recorded cassette, remove its safety tab. To record on it later, cover the hole with adhesive tape.

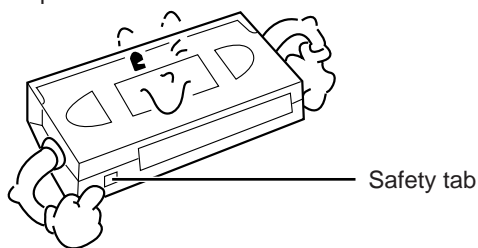

To watch a compact VHS tape

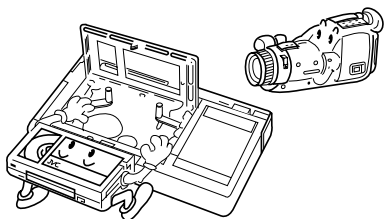

Compact VHS camcorder recordings can be played on your Player. Place the recorded cassette into a Cassette Adapter and it can be used like any full-sized VHS cassette.

Playback (Video cassette player)

NTSC, PAL and MESECAM video tapes can be played back on this Player. Refer to the "Colour system output mode selection (P. 9)" section for details.

Before proceeding:

- Turn on the power of the TV and Player.
- Make sure that the TV's TV/VIDEO switch is set to VIDEO.
- Press the remote control's VHS button.

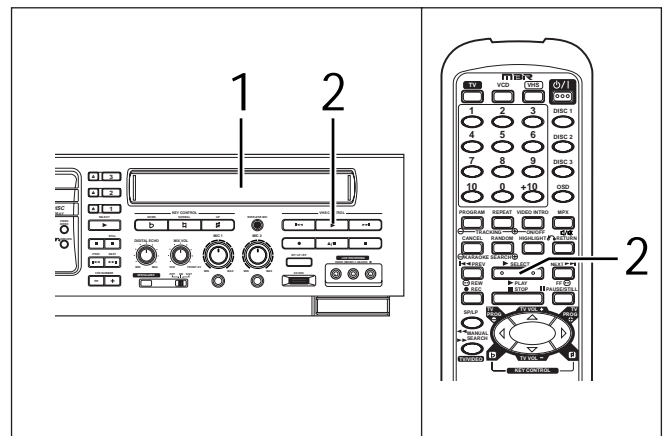

- 1 Load a pre-recorded cassette.**
If the safety tab on the cassette is removed, playback will start automatically.
- 2 Press the Play ► button to start playback.**

- **Press the Stop/Eject ■/▲ button or the remote control's Stop ■ button to stop playback.**

To fast forward or rewind the tape:

- **From the stop mode, press the remote control's Fast forward ►► or Rewind ◀◀ button.**

NTSC Playback on PAL TV

- The vertical size of the playback picture will shrink and some picture "noise" may appear on the screen.
- The playback picture may roll. In this case adjust the picture with the TV's vertical hold knob (with some TV's this adjustment may not be possible).
- The colour of the playback picture may differ from the original.
- In the forward/reverse shuttle search or still modes there may be no colour depending on the TV and Player combination.

Playback Features

In order to operate by remote control, first press the VHS button.

Slow motion playback

Slow motion playback is 1/6 of the normal playback speed. The sound will be cut during slow motion playback.

During playback:

- 1 Press the Pause **II** button for 2 seconds.
- Press the Play **▶** button to return to the normal playback speed.

Notes:

- If the picture shakes during the slow mode, use the manual tracking +/- buttons to correct the picture.
- There will be some picture disturbance and loss of colour during slow motion playback.
- After approx. 5 minutes, the slow mode will disengage to protect the video tape.

Still picture and frame advance

Use this feature to freeze the playback picture and to advance one frame at a time. The sound will be cut during this mode.

During playback:

- 1 Press the Pause **II** button.
The picture will be frozen.
 - 2 Press the Pause **II** button repeatedly to advance frames.
Each time the button is pressed the still picture will advance one frame.
- Press the Play **▶** button to resume normal playback.

Notes:

- If the picture shakes during the still mode, use the manual tracking +/- buttons to correct the picture.
- After the picture has been frozen for approx. 5 minutes, the still mode will disengage to protect the video tape.

Shuttle search playback

Use this feature during playback to visually locate any point on a recorded cassette. The sound will be cut during shuttle search operation.

During playback:

- 1 Press the remote control's Fast forward **▶▶** or Rewind **◀◀** button to engage shuttle search forward or reverse.
- Press the Play **▶** button to resume normal playback.

Notes:

- When the Player is in the stop mode, press the Play **▶** button to start playback before engaging the shuttle search mode.
- For short searches, keep Fast forward or Rewind button pressed for more than 2 seconds. When released, normal playback will continue.
- Disturbances in the shuttle search picture are normal and do not indicate a problem with the Player.

Repeat playback

Use this feature to repeat playback of a cassette 20 times.

During playback:

- 1 Press the Play **▶** button for more than 5 seconds.
The Play **▶** indicator will blink slowly and playback of the cassette will repeat 20 times automatically.
- 2 Press the Stop **■** button to stop repeat playback.
Tape playback will be stopped and the repeat playback mode will be cancelled.

Rewind power off

When the tape has finished rewinding, the Player will turn itself off.

During stop:

- 1 Press the remote control's Rewind **◀◀** button.
- 2 Press the **⏻** button within 2 seconds.
“◀◀” indicator blinks on the display panel.

Tracking adjustment

Automatic tracking is adjusted each time a cassette is inserted in the Player, you may wish to adjust tracking manually during playback.

Manual tracking:

- 1 Press the remote control's ON/OFF button.
 - 2 Press the remote control's TRACKING + or – button to adjust tracking.
- Press the ON/OFF button to return to automatic tracking.

Notes:

- Tracking may need to be adjusted each time a different video tape is inserted for playback.
- Tracking will be automatically set to the reference position when the cassette is ejected.

Soundtrack selection

Your Player is capable of recording three soundtracks (HIFI L, HIFI R and NORM) simultaneously, and playing back the selected soundtrack.

During Playback:

- 1 Press the remote control's Audio monitor **🔊/🔇** button to change the soundtrack.

Track (on display panel)	Use
L + R	for Hi-Fi stereo tapes
L	for main audio of bilingual tapes
R	for sub audio of bilingual tapes
No indication (normal)	for audio-dubbed tapes
L + R (blink)	mixed normal and L+R audio

Note:

- Normally use the “L+R” position. Then Hi-Fi stereo tapes are played back in stereo, and tapes with normal audio only are played back automatically in the normal mode.

Playback Features (cont'd)

Karaoke search

Use this feature to access to the start of the next tune to be sung.

- 1 Press **Karaoke search** \lll or \ggg button on the front panel.
Playback will start automatically, when the specified song is found.

Notes:

- Karaoke search does not work with a tape which has no signal on its normal soundtrack. Also, if the length of blank parts between tunes is shorter than 3 seconds, if the tune has a fade-out ending, or if the tape contains excessive noise signals, Karaoke search may not work properly with that tape.
- When you are not using the microphone, disconnect the microphone from the MIC input terminals. When connecting and disconnecting the microphone, it is recommended to set the power of Player to OFF.

Spatializer®

This function improves the realistic effect of the audio during playback or recording.
Spatializer® has no effect on recording quality.

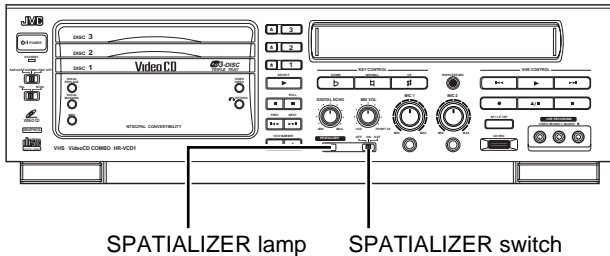

Select the desired audio with the SPATIALIZER switch.

- The SPATIALIZER lamp lights up when "ON" or "S.ST" is selected.

OFF	Set to this position to enjoy the original audio.
ON	Set to this position to enjoy a movie or music program in stereo audio with an enhanced quality.
S.ST	Set to this position to enjoy monaural audio tape in simulated stereo. (S.ST: Simulated Stereo)

Notes:

- Spatializer® is effective only with a stereo TV.
- When this Player is used as the player for editing, the recorded audio will correspond to the Spatializer® setting.
- Set to OFF when using a microphone.
- The picture may be disturbed or the sound volume may be distorted depending on which unit is connected. This is because the sound volume will be higher in the ON or S.ST positions.

Recording

Use the following procedure to record TV programmes on a blank video tape.

Before proceeding:

- Connect the TV's VIDEO and AUDIO OUT connectors to the Player's VIDEO and AUDIO IN connectors.
- Turn on the power of the TV and Player.
- Make sure that the video cassette's safety tab is intact. If it has been removed, cover the hole with adhesive tape.
- Press the remote control's VHS button.

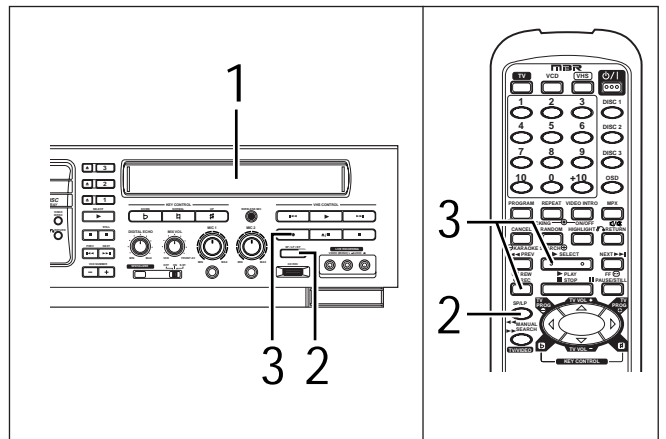

- 1 Load a blank video tape.
- 2 Press **SP/LP/EP** button to select the tape speed.
- 3 Press the **Record** button to start recording. (On the remote control unit press the **REC** and **PLAY** button at the same time.)

- Press the **Stop/Eject** button or the remote control's **STOP** button to stop recording.

To stop recording temporarily:

- Press the **Pause** button.
Press the **Play** button to resume recording.

Notes:

- To engage recording standby, press the **Record** button and then press the **Pause** button. Press the **Play** button again to start recording.
- If the **Record** button does not work, check to see if the cassette safety tab has been removed.
- The player automatically stops when record-standby continues for more than 5 minutes.
- The video tape will be rewound automatically when the end of the tape is reached.

Karaoke Features

Connecting to Hi-Fi stereo system

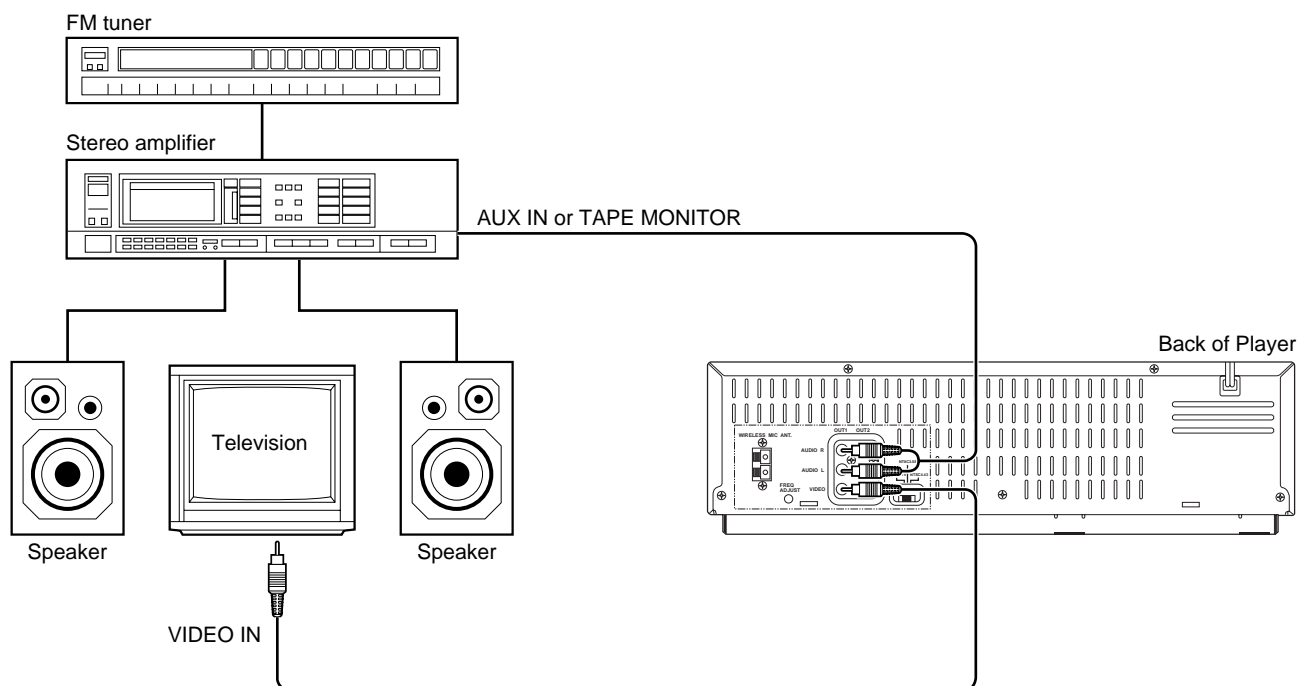

If you have a Hi-Fi stereo system, you can connect your Player to it so that the sound can be heard through your Hi-Fi system. Please make these additional connections:

Hi-Fi audio connection

- 1 **Connect the AUDIO OUT "L" and "R" connectors of the player to the AUX IN or TAPE MONITOR terminals of the amplifier.**

Notes:

- Make sure "L" and "R" are correct when connecting the audio input and output connectors of the player to a stereo amplifier.
- When listening to sound from the connected stereo system, turn down the sound volume of the TV completely.

CAUTION:

- This player has a dynamic range of more than 90 dB with regards to its Hi-Fi audio capability. It is recommended that you check the maximum level if you are going to listen to the Hi-Fi audio signals through a stereo amplifier. A sudden surge in speaker input may cause speaker damage.
- Some speakers and televisions are specialty shielded to prevent television interference. If both are of the non-shielded type, do not place the speakers adjacent to the TV set, otherwise the video playback picture may be adversely affected.

Karaoke Features (cont'd)

Microphone

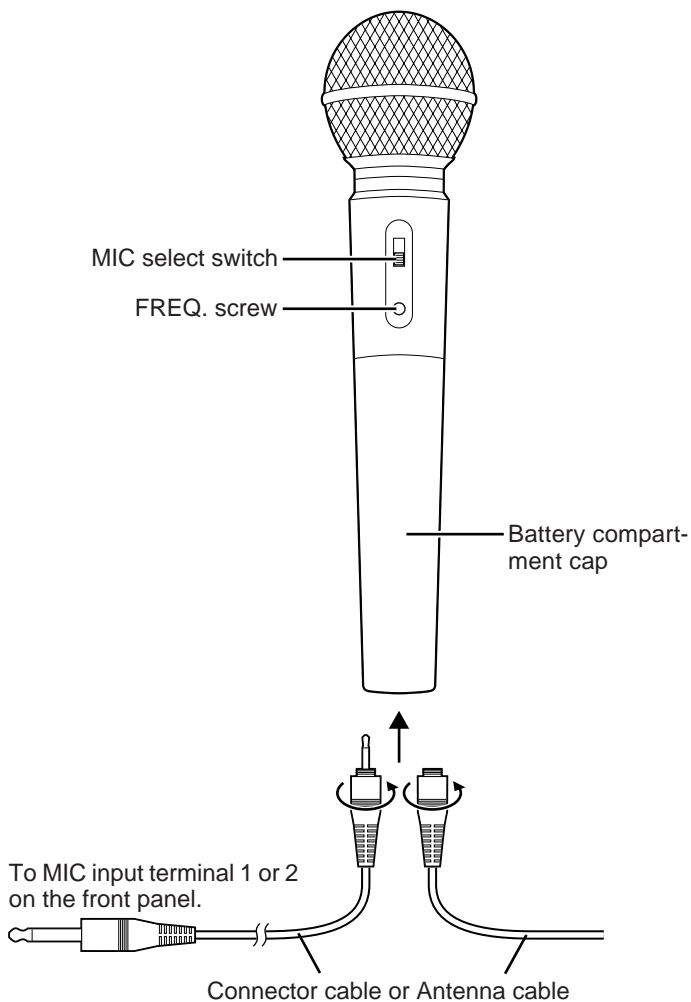

How To Use

To use as a wired microphone

- 1 Insert the connector cable to the end of the Microphone as illustrated and turn it clockwise to fix.
- 2 Set the MIC select switch to "WD. (Wired)".

To use as a wireless microphone

- 1 Insert the antenna cable to the end of the microphone as illustrated and turn it clockwise to fix.
- 2 Set the MIC select switch to "WL. (Wireless)".

ATTENTION:

When you are not using the microphone, it is recommended to set the MIC select switch to OFF; otherwise the batteries will discharge even when not in use.

Installing Batteries

- 1 Unscrew and remove the battery compartment cap.
- 2 Insert 2 "AA/UM-3"-size batteries (provided) in the correct directions.
- 3 Screw the cap back on.

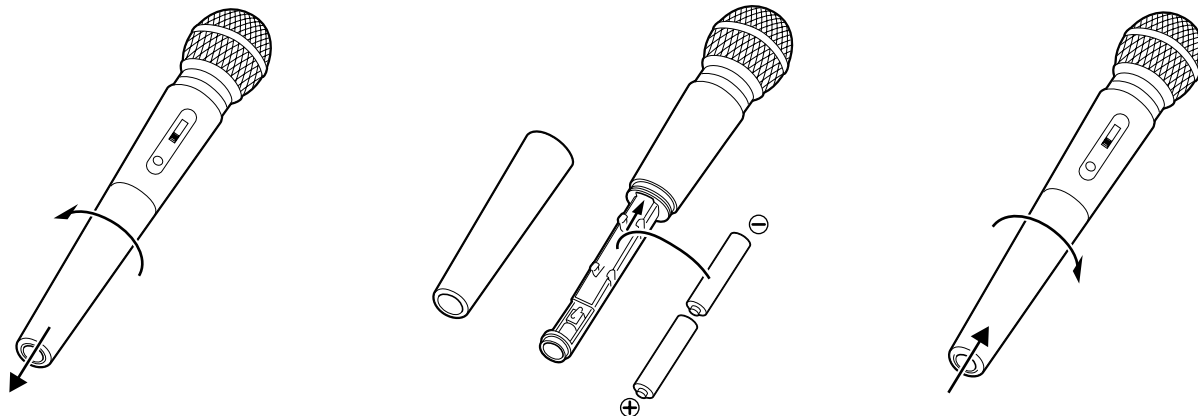

Karaoke Features (cont'd)

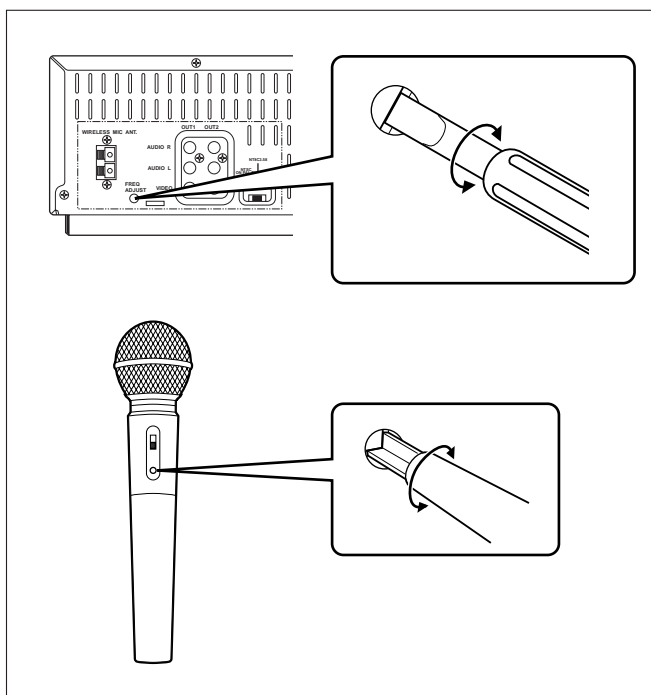

If there is interference when using the microphone

Follow the steps below to re-adjust the frequency of the microphone and your Player.

Preparation

1. Turn on your TV and Player.
2. Select the TV's VIDEO channel.
3. Press the WIRELESS MIC button on the Player's front panel.

■ The WIRELESS MIC indicator will light.

4. Set the microphone's MIC select switch to "WL. (Wireless)".
5. Turn the MIC knob on the front panel of the player in order to adjust to the desired sound volume.
6. Set the MIX VOL knob on the player's front panel to the center or VCD.

Operation

1. Turn tightly the FREQ. screw on the Player's rear panel in either direction with the provided screwdriver (attached at the rear of the battery compartment).
2. While speaking into the microphone continuously. Turn the microphone's FREQ. screw with the provided screwdriver in the same direction as in step 1. until your voice can be clearly heard from the TV's speaker.

Check

1. First set the microphone's MIC select switch to "OFF". And set the switch to "WL. (Wireless)".
2. Speak into the microphone and check if your voice can be heard from the TV's speaker.

■ If your voice cannot be heard. Try again steps 1 and 2 of "Operation".

The Karaoke Control Centre on the Player's front panel gives you direct access song search, and sound volume/echo control. The provided microphone can also be used as a wireless microphone.

Preparation

To use the microphone as a wireless microphone

You need to connect the provided FM feeder cable to the Player.

- 1 While you press the lever, connectors, insert the provided FM feeder cable into the connectors.

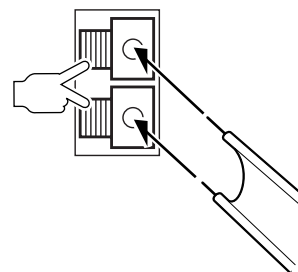

- 2 Release the lever.

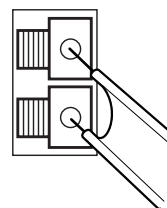

- 3 Hang the FM feeder cable on the wall behind the Player so that the cable forms a "T".

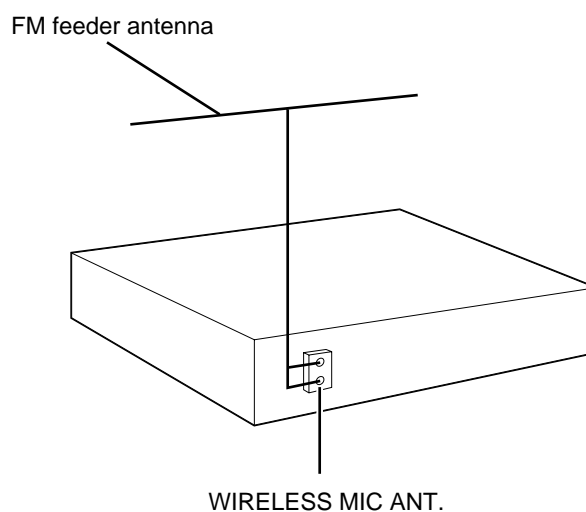

Karaoke Features (cont'd)

- 4 Follow steps 1 and 2 of "To use as a wireless microphone". (☞ p.22)
- 5 Press the Player's WIRELESS MIC button to make the button light.

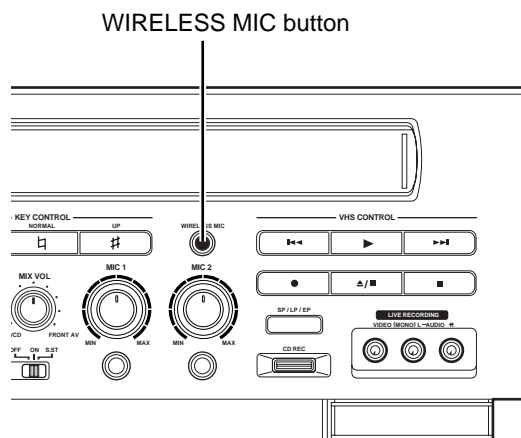

Basic operations

- 1 Turn on the TV and select VIDEO channel.
- 2 Set the microphone's switch to "WD. (Wired)".
- 3 Insert the disc or a pre-recorded Karaoke tape.
 - If the safety tab on the cassette is removed, playback will start automatically.
- 4 Press Play ► button.
- 5 Start singing.

To use the microphone as a wired microphone

- 1 Follow steps 1 and 2 of "To use as a wired microphone". (☞ p.22)
- 2 Connect the microphone to the Player's front panel MIC1 or MIC2 terminal.

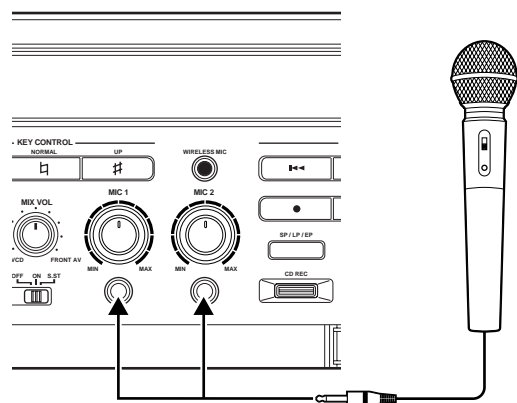

Notes:

- When using a wire-less microphone, the player may not receive the sound volume if it is too far away from the player.
- You can use up to 3 microphones (2 wired and 1 wireless) at the same time with this Player.

Karaoke Features (cont'd)

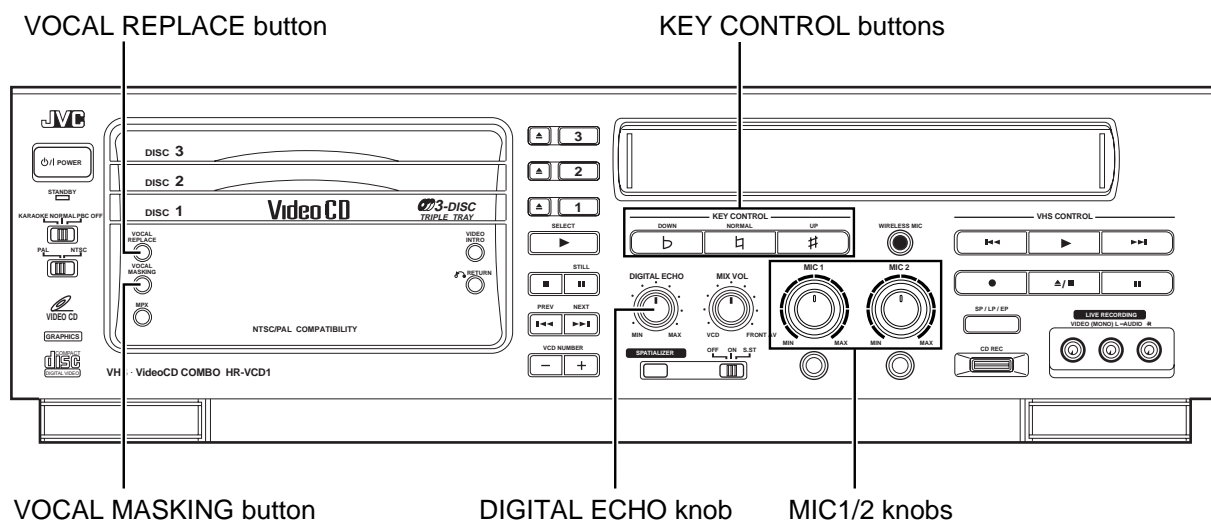

Vocal replace

Preparation

This function is used for multiplex sound discs and tape.

Operation

1. Press the **VOCAL REPLACE** button during play or stop. **REPLACE** will appear on the display window and **VO.REPLACE** will appear on the television screen. When you start singing, the vocal of the disc is removed and your voice is inserted into the music.
2. To cancel voice replacement, press the **VOCAL REPLACE** button again.

Vocal masking

Preparation

A digital audio CD and tape with vocals is used for KARAOKE.

Operation

1. Press the **VOCAL MASKING** button during play or stop. The Player plays the music with low level vocals recorded on the disc. **MASKING** will appear on the display window and **VO.MASKING** will appear on the television screen.
2. To cancel vocal masking, press the **VOCAL MASKING** button again.

ATTENTION

Be sure to remove the microphone

Note when connecting the sound output to the input of a TV or VCR:

If an excessively strong signal is given to a unit through a microphone, for example when using Karaoke, it may cause an adverse effect such as distorted sound. Lower the sound volume using the microphone control.

Karaoke etiquette

Be aware of your neighbors when enjoying karaoke music. Particularly late at night, the sound you enjoy may reach your neighbors more than you expect. Common sense and courtesy are always appreciated.

MIC volume adjustment

Turn the **MIC 1** or **MIC 2** knobs clockwise (level up) or counterclockwise (level down) as desired. When using a wire-less microphone, adjust with the **MIC 2** knob.

Adjusting music key

Press the **KEY CONTROL** buttons (**b** or **#**) to change the key in which the music plays. You can adjust the music on the remote control unit also.

To return the music to its original key, press the **NORMAL** button. Remote control is not available for operation.

Notes :

- The degree the key has been sharpened or flattened is displayed on the television screen.
- When the song ends the key control will return to **NORMAL** mode automatically.

Adjusting echo effect

Turn the **DIGITAL ECHO** knob clockwise (level up) or counterclockwise (level down) to adjust the echo effect as desired.

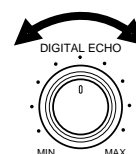

Editing

Editing to/from another recorder

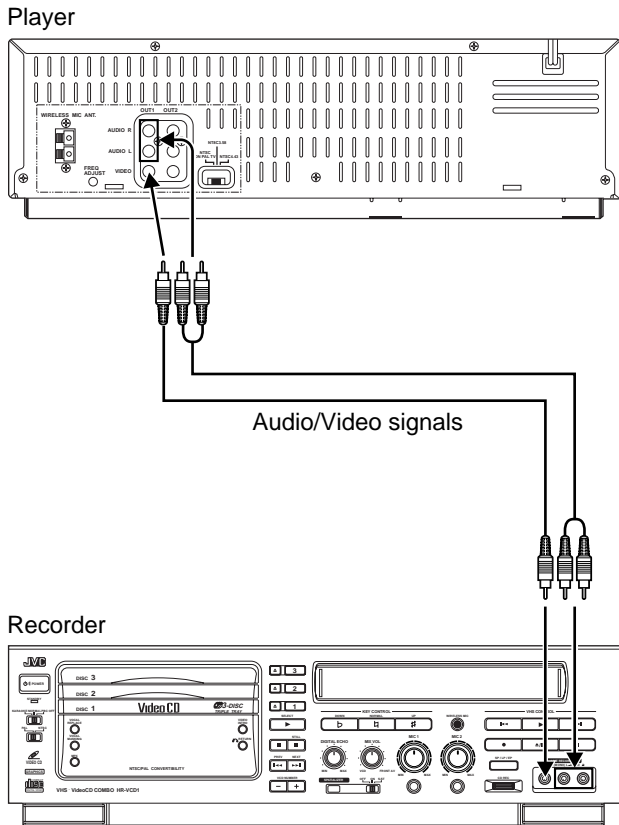

Preparation

Connect the player's AUDIO and VIDEO OUT connectors to the recorder's AUDIO and VIDEO IN connectors.

- 1 **Select the recorder's external input mode.**
 ■ When this unit is beside the recorder, there is no need for any operations.
- 2 **Put the player in the Play mode.**
- 3 **Put the recorder in the Recorder mode.**

Notes:

- NTSC tapes being played back in the NTSC PLAYBACK ON PAL TV mode cannot be dubbed to another recorder.
- When you dub an NTSC tape using this unit as the playback deck, select NTSC 3.58 (or 4.43) with the Colour System Output switch.

Editing from a camcorder

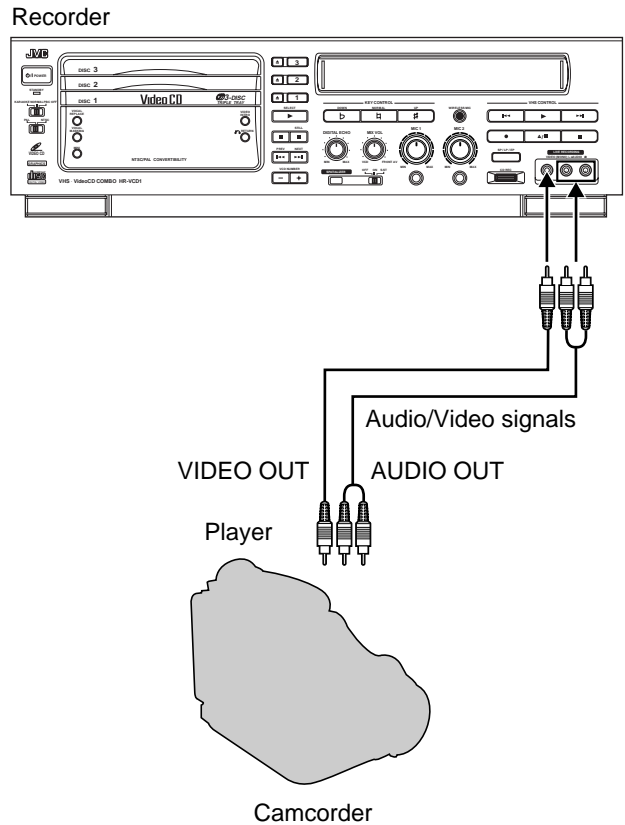

Preparation

Connect the camcorder's AUDIO and VIDEO OUT connectors to the recorder's AUDIO and VIDEO IN connectors.

- 1 **Put the camcorder in the Play mode.**
- 2 **Put the recorder in the Record mode.**

Important:

- To edit, both the player and the recorder must be of the same colour system. Set this unit's Colour system switch to select the appropriate colour system.

Editing (cont'd)

CD Recording

This function dubs the audio of a CD onto a video tape by a simple procedure.

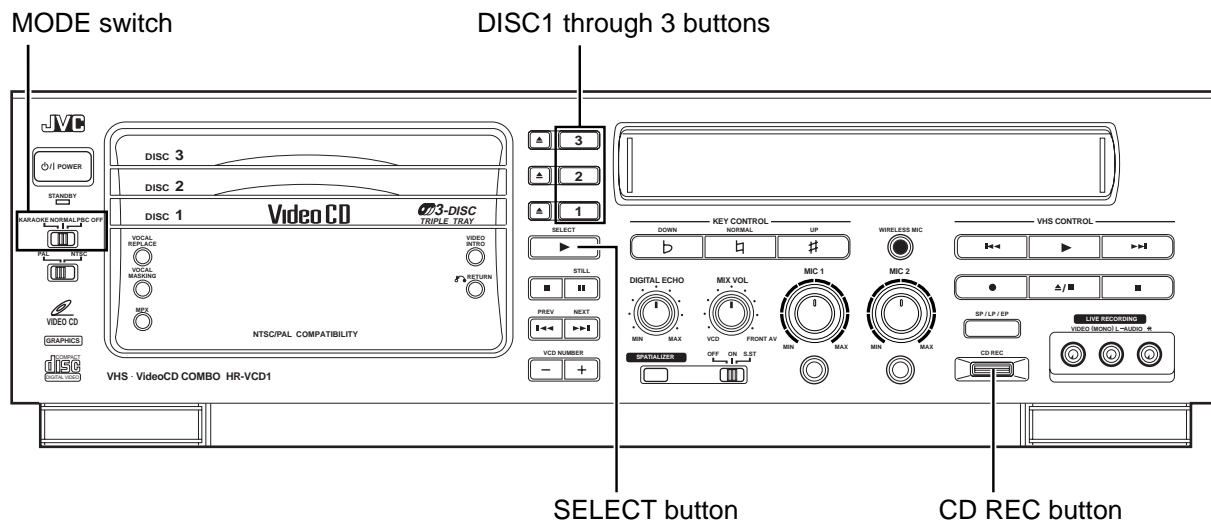

Preparation

- Set the MODE switch of the Player either to "PBC OFF" or "KARAOKE".
- Set the MIX VOL knob on the player's front panel to the center or VCD position.

Operation

- 1 Load a cassette.**
 - Insert the cassette to be recorded on into the Player.
- 2 Place the disc to be played on the disc tray of the Player.**
- 3 Press the CD REC button of the Player.**
 - The lamp in the CD REC button lights up and the VCR enters the record-pause mode.
 - ●|| appears in the display panel of the Player.
- 4 Press the ► SELECT button or one of the DISC 1 to 3 buttons of the CD player.**
 - The CD player starts playback, the Video cassette player (VCP) starts recording, and the audio of the CD is recorded onto the video tape.
 - The audio of the CD are output at the monitor TV.
 - Switching the CD player to stop or pause mode during dubbing puts the VCR in record-pause mode. To resume dubbing, play the track to be dubbed.
- 5 Press the CD REC button to stop CD recording.**
 - The lamp in the CD REC button turns off and both the CD player and the VCP stop.

Editing (cont'd)

Live recording

This is a function which records both the singing style and the Video CD sound simultaneously with the video tape.

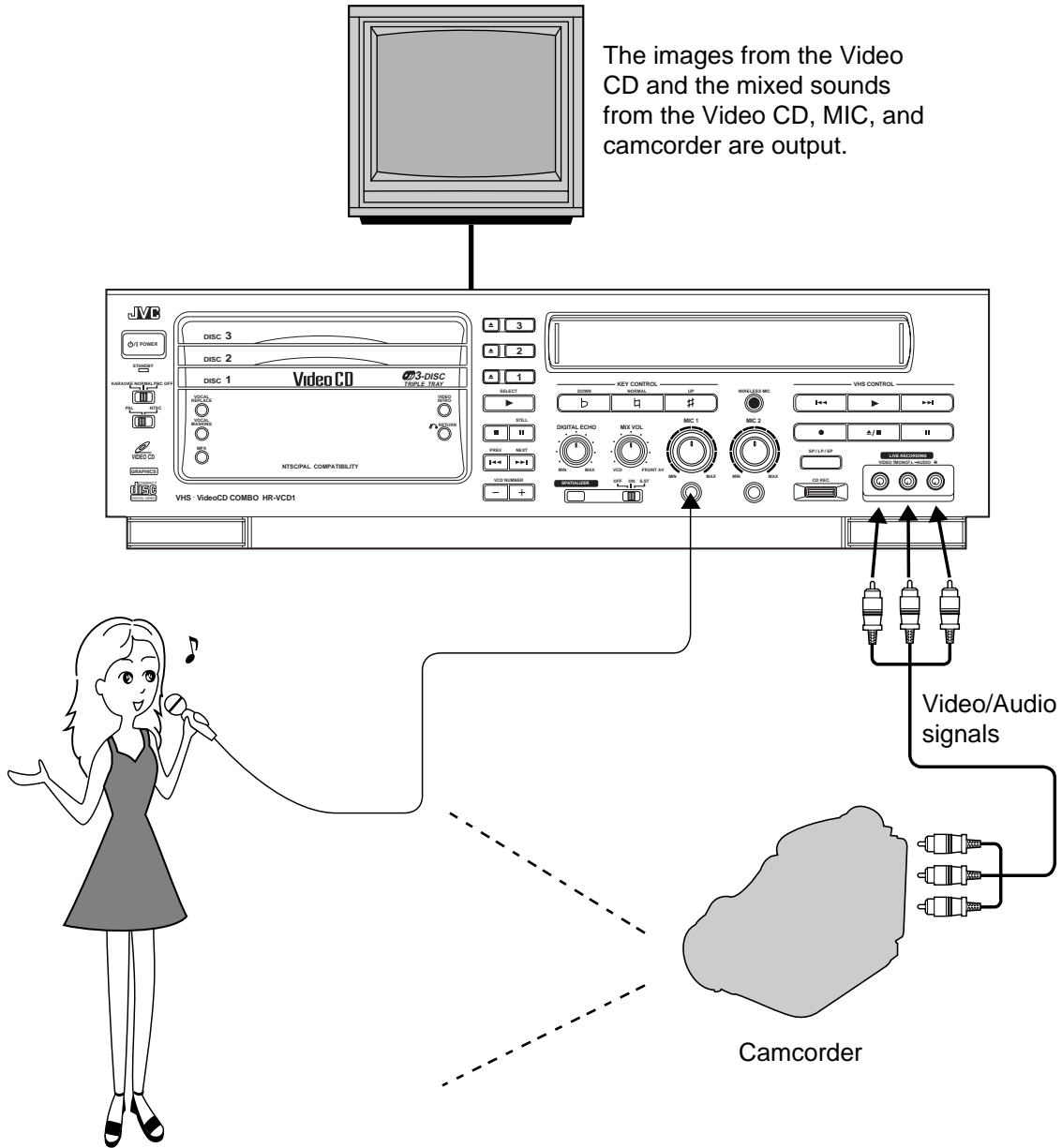

The images from the Video CD and the mixed sounds from the Video CD, MIC, and camcorder are output.

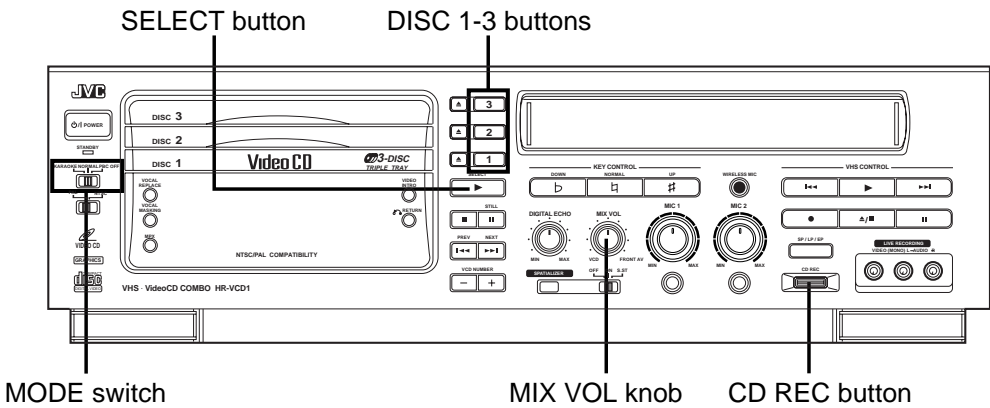

Editing (cont'd)

Live recording

Preparation

Set the MODE switch of the Player either to "PBC OFF" or "KARAOKE".

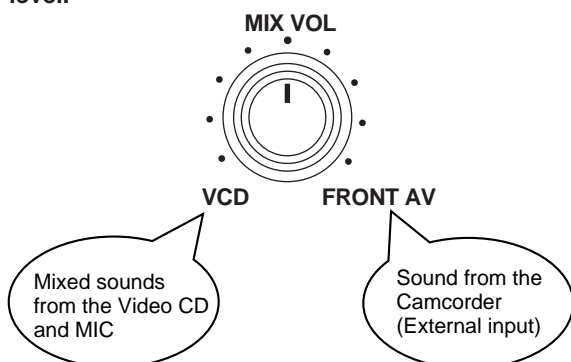

Operation

- 1 **Connect the equipment as shown in the illustration on the left.**
- 2 **Load a cassette.**
 - Insert the cassette to be recorded in the Player.
- 3 **Place the disc to be played on the disc tray of the Player.**
- 4 **Shoot the image to be recorded with the camcorder.**
 - For the operating procedure of the camcorder, refer to the instruction manual.
- 5 **Adjust the MIX VOL knob of the Player to the desired level.**



- 6 **Press the CD REC button of the Player.**
 - The lamp in the CD REC button lights up and the VCR enters the record-pause mode.
 - **●||** appears in the display panel of the Player.
- 7 **Press the ► SELECT button or one of the DISC 1 to 3 buttons of the Video CD player.**
 - As the Video CD is played, the Video cassette player (VCP) begins to record the images from the camcorder together with the mixed sounds from the Video CD, MIC, and camcorder.
 - The images from the Video CD together with the mixed sounds are output to the TV.
 - Switching the Video CD player to stop or pause mode during recording puts the VCP in record-pause mode. To resume recording, play the track to be recorded.
- 8 **Press the CD REC button to stop live recording.**
 - The lamp in the CD REC button turns off and both the Video CD player and the VCP stop.

Troubleshooting

Symptoms	Check point
No power is applied to the Player.	<ul style="list-style-type: none"> ■ Is the power cord disconnected? – Connect it.
Remote control does not function.	<ul style="list-style-type: none"> ■ Are the batteries discharged? – Replace with new ones.
Disc tray does not come out when OPEN/CLOSE button is pressed.	<ul style="list-style-type: none"> ■ Is the power cord disconnected? – Connect it.
Sound is distorted or noise is generated. Image is garbled.	<ul style="list-style-type: none"> ■ Is the disc dirty? – Wipe off the disc surface with a soft cloth. ■ Is the correctly connected?
Sound is intermittent. Image is garbled.	<ul style="list-style-type: none"> ■ Is the disc dirty? – Wipe the disc surface with a soft cloth. ( p.4) ■ Is the disc scratched? ■ Is the disc warped? – Replace the disc with a new one.
No image is displayed on the monitor.	<ul style="list-style-type: none"> ■ Is the monitor set to the AV mode? – Set it to the AV mode.
Noise appears during visual search.	<ul style="list-style-type: none"> ■ This is normal.
Noise appears during normal or slow-motion playback.	<ul style="list-style-type: none"> ■ Is the automatic tracking mode engaged? – Try manual tracking. ( p.19)
No sound from the microphone is heard.	<ul style="list-style-type: none"> ■ Is the microphone volume adjusted at the lowest level? ( p.25)
Recording does not function.	<ul style="list-style-type: none"> ■ Is a cassette loaded? ■ Is the safety tab on the cassette removed? – Reseal the slot with adhesive tape.
Tape-to-tape editing or camera recording is not possible.	<ul style="list-style-type: none"> ■ Is the camcorder or another video recorder correctly connected? ■ Are all necessary power switch turned ON?
Whistling or howling is heard from TV during camera recording.	<ul style="list-style-type: none"> ■ Move camcorder or camera's microphone away from TV or reduce TV sound volume.
The Player does not function properly.	<ul style="list-style-type: none"> ■ Microcomputer malfunction. Disconnect the power plug from the AC outlet and then re-insert it. The microcomputer will be reset to its initial mode.

Specifications

GENERAL

Power requirements	
Rating	AC 110 – 240 V, 50/60 Hz
Operating	AC 90 – 260 V, 50/60 Hz
Power consumption	25 W
Temperature	
Operating	5°C to 40°C
Storage	-20°C to 60°C
Dimensions (W x H x D)	460 × 135 × 341 (mm)
Weight	7.5 kg

VIDEO CD

Playback disc	Video CD (with/without Playback Control function) CD Graphics Digital Audio CD
Total harmonic distortion	Less than 0.015% (1 kHz)
Signal-to-noise ratio	More than 90 dB
Frequency response	20 Hz to 20,000 Hz

VIDEO

Format	VHS Standard
Recording/Playback system	DA-4 (Double Azimuth) head herical scan system
Recording (line input)	PAL, SECAM (MESECAM tape) NTSC 3.58, NTSC 4.43
Playback (line output)	PAL, SECAM (MESECAM tape) NTSC 3.58, NTSC 4.43 Simulated PAL (NTSC tape)
Signal-to-noise ratio	More than 45 dB
Horizontal resolution	More than 250 lines (PAL/ MESECAM) More than 220 lines (NTSC)
Input	0.5 - 2.0 V _{p-p} /75 ohms, unbalanced
Output	1.0 V _{p-p} /75 ohms, unbalanced

AUDIO

Frequency response	70 Hz to 10,000 Hz (Normal) 20 Hz to 20,000 Hz (Hi-Fi)
Input	-8 dBs/50 k ohms, unbalanced
Output	-6 dBs/1 k ohms, unbalanced
MIC input	-56 dBs/50 k ohms, unbalanced

ACCESSORIES

Provided accessories	
Remote control unit	1
"AA/UM-3" battery	4
Audio/Video cable	1
Microphone	1
FREQ. adjust screwdriver	1
Connector cable	1
Antenna cable	1
FM feeder cable	1

- Design and specifications subject to change without notice.

JVC
VICTOR COMPANY OF JAPAN, LIMITED